

Power Sources of Military Helicopters

Béla VARGA¹

In the early 1940s the first practically usable helicopters rose into the sky. Their importance was quickly recognised both by the military and civilian decision makers. A good summary of their most important advantage is the next quotation: “If you are in trouble anywhere in the world, an airplane can fly over and drop flowers, but a helicopter can land and save your life.” (Igor Sikorsky, 1947) Just after their appearance it immediately became an urgent problem to replace the relatively low-power and heavy piston engines, for which the much lighter and more powerful turboshaft engines offered a good alternative. Significant improvement of helicopter engines, which has embodied mainly in power to weight ratio, thermal cycle efficiency, specific fuel consumption, together with reliability and maintainability, of course, has influenced the technical-tactical parameters of helicopters. In this paper I introduce the evolution of helicopter turboshaft engines, the most important manufacturers and engine types. Through statistical analysis I display what kind of performance parameters the helicopter turboshaft engines had in the past and have in the present days.

Keywords: *helicopter gas turbine engines, turboshaft, shaft power, specific fuel consumption, thermal efficiency, specific net work output, specific power*

The Beginning of the Gas Turbine Era

By the end of World War II, piston engine and propeller driven aircraft reached their performance limits. This meant their flying speed slightly exceeded 700 km/h. The flight altitude of an average fighter reached 12 km, the special reconnaissance planes could even reach 14 to 15 km. Good example for this process is one of the most well-known fighter plane of World War II, the Messerschmitt Bf 109, which went through numerous development phases. In Table 1 I have listed some of the main variants of this aircraft, illustrating that the more and more powerful engines did not yield a breakthrough result considering their flying speed.

Table 1. Performance data of Bf 109. [1]

Version	Year	Engine	Power (HSP ²)	Speed (km/h)
Bf 109B	1937	Jumo 210	720	466
Bf 109D	1938	DB 600	960	514
Bf 109E	1939	DB 601A	1175	569
Bf 109F	1941	DB 601N	1200	614
Bf 109G	1942	DB 605	1475	643
Bf 109K	1944	DB 605D	2000 (methanol injection)	724

¹ Associate Professor, National University of Public Service, Institute of Military Aviation;
e-mail: varga.bela@uni-nke.hu

² HSP—Horse Shaft Power

These problems were already well-known even before World War II, although airplanes that time did not yet approached these limits. Using aerodynamic laws, it is easy to see that the necessary power is proportional with the cube of the flying speed, not to mention the ever-increasing amount of weaponry, which also required extra power. Accordingly, several researchers started to seek new directions for the aircraft engine developments. In the international arena, the British Frank Whittle's researches were particularly important, whose gas turbine engine in the 1930s (Figure 1, left) had all the components, which a modern gas turbine has.

Despite Whittle's leading role in gas turbine engine development, the first jet engine (Heinkel HE S3) built in an aircraft, was designed by Hans von Ohain. This engine pushed a Heinkel HE 178 aircraft, which accomplished its maiden flight on 27 August 1939.

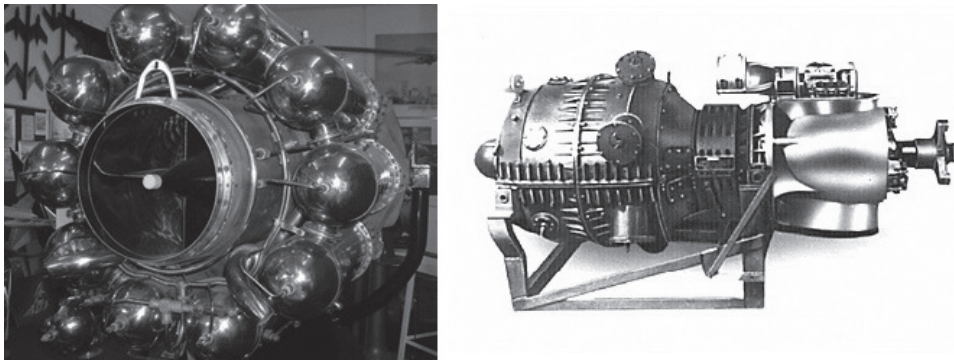

Figure 1. *To the left Frank Whittle's engine, [2]
to the right Jendrassik's shaft power producing gas turbine. [3]*

But we should not forget about the Hungarian György Jendrassik, who was already a prestigious engineer at the Ganz factory when he started to develop his gas turbine engine. The first of his gas turbine patents was dated on 12th March 1929. In 1938, his 75 kW power plant was the first in-use gas turbine in such a small size (Figure 1, right). His results worthily earned sensation. The machine achieved 21.2% effective thermal efficiency at 16,400 RPM³ while it produced 72.5 kW shaft power. The maximum turbine inlet temperature was 475 °C and the compressor pressure ratio⁴ 2.2:1. With such a low turbine inlet temperature and small size, nobody achieved such a high efficiency, not even today. This good efficiency was achieved by a heat exchanger⁵ application. Both the axial compressor and the turbine had new unique solutions: both with slightly curved blades and stages having 50% degree of reaction.⁶ Compressor efficiency was 85%, turbine efficiency 88%. [3] This gas turbine engine is also considered to be the ancestor of the shaft power producing gas turbines.

In the 40s, gas turbine engines (jet engines) appeared in such aeroplanes like the German Messerschmitt Me 262, Arado 234, or in the British Gloster Meteor (though the latter did not

³ RPMc—revolutions per minute.

⁴ Compressor pressure ratio: the ratio of the air pressure exiting the compressor to the air pressure entering the compressor.

⁵ Heat exchanger: compressor air is heated by the hot exhaust gas flow in a counter-flow heat exchanger.

⁶ 50% degree of reaction is when the pressure enthalpy change is equally shared by the stator and the rotor.

have a battlefield role). In the 1950s, the gas turbine era was definitely and irreversibly blown into the aviation.

Specialisation of Gas Turbine Engines

In case of the first practically used gas turbine engines the thrust producing component was in the rear section of the engine, namely the nozzle. Consequently, it became the first category of gas turbine engines, the pure single-spool turbojet engine, shortly pure turbojet. However, their further specialization started almost immediately and three more distinct categories emerged. These are turboprops, turboprops and turboshafts.

In Figure 2, three, though somewhat modified, but practically pure turbojets (with afterburner⁷ and two-spool with afterburner) are seen from the top right to the bottom right. The last two engines to the right are turbofan engines, their bypass ratio is the difference between them.⁸ The left-hand one is a low bypass ratio turbofan, which is nowadays the typical engine of multirole combat aircrafts and advanced training and light attack aircrafts.

The right-hand engine is a high bypass ratio turbofan which is used on passenger planes. However, the right-side engines also represent an evolutionary process; airliners went through this process from using pure turbojet (without afterburner) to high bypass ratio turbofan with 6–10 bypass ratio, significantly reducing their specific fuel consumption (increasing efficiency).

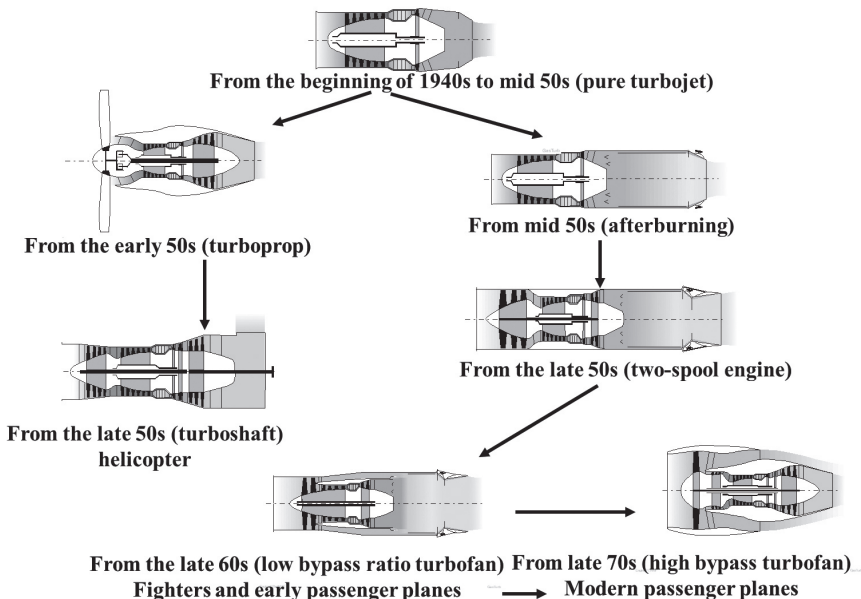

Figure 2. *Evolution of gas turbine engines.* [Edited by the author.]

⁷ Afterburner: thrust augmentation, achieved by injecting additional fuel into the jet pipe downstream of the turbine.

⁸ Bypass ratio: the ratio between the mass flow rate of the bypass stream to the mass flow rate entering the core.

The left side turboprop engine is the engine of military transport aircrafts and short-range, typically small and medium-sized passenger planes. This is followed by a turboshaft, which is the typical engine of the helicopters.

Of course, the aircraft engines (maybe a more complex and appropriate expression would be propulsion systems) can be classified by how the thrust is generated, as shown in Figure 3. Thrust is the force which moves any aircraft forward, generated by the aircraft propulsion system. Different propulsion systems develop thrust in different ways, but all thrust is generated through the application of Newton’s third law of motion, namely for every action there is an equal and opposite reaction. In any propulsion system some kind of working fluid is accelerated by the system and the reaction to this acceleration produces a force (thrust) on the system. Here we have to take into consideration that all aircraft propulsion systems can be divided into two basic components, such as a power generator and the accelerator. The power generator is actually, in most cases, a heat engine, which accomplishes well-known classical thermodynamic cycles, like Otto, Diesel, Brayton. The accelerator is the structural unit which provides the thrust force, i.e. propeller, helicopter rotor, nozzle, fan stage or a combination of these items. A general derivation of the thrust equation shows that the amount of the generated thrust depends on the mass flow rate through the propulsion system and the difference between exit and inlet velocity (acceleration) of the working fluid.

It means that the principle of thrust derivation is the same in any case despite differences in structure of propulsion systems. But by the differences we can define some typical propulsion systems.

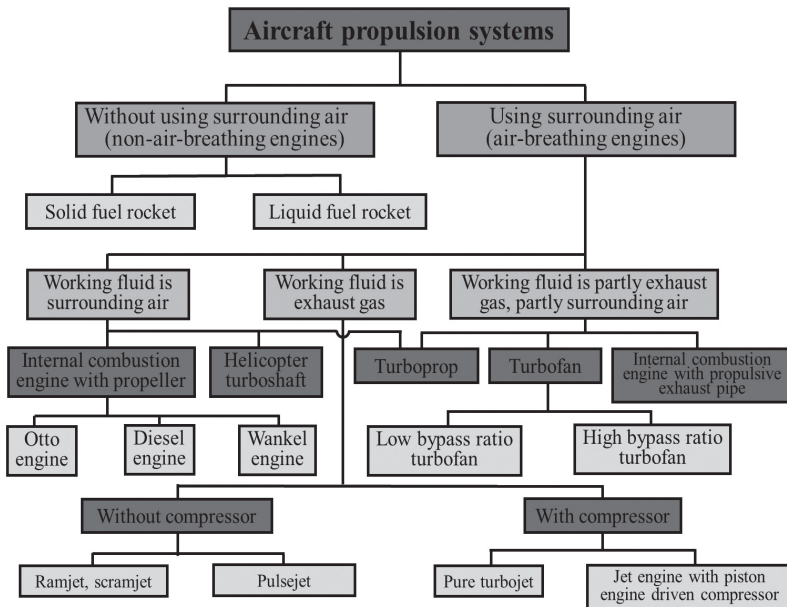

Figure 3. Classification of aircraft propulsion systems.

[Edited by the author.]

From this point of view, aircraft (air-breathing) engines can be classified into three main categories, see the light brown row in Figure 3. Today the non-air-breathing engines can be excluded as aircraft propulsion systems:

- propulsion system where the accelerated working fluid is the surrounding air;
- propulsion system where the accelerated working fluid is the hot exhaust gas of the heat engine;
- propulsion system where the accelerated working fluid is partly the surrounding air partly the hot exhaust gas of the heat engine.

Apparently, gas turbine engines (turbojet, turbofan, turboprop, turboshaft) appear in all three of the aforementioned categories.

The Born of Shaft Power Producing Gas Turbine

Already in 1943, the possibility of using gas turbines to produce shaft power was considered in Germany to install them in newly-developed armoured vehicles, mainly in tanks. The design and construction of several more or less similar engines lasted from mid-1943 to early 1945. They were developed by Adolf Müller and signed from GT 101 to GT 103. With them a new category of gas turbines was born namely the *turboshaft*. The reason of this development was that the power to weight ratio of this gas turbines was much better than that of the piston engines with similar shaft power. Of course, there were disadvantages of the plan, too. The most significant is the expected bad thermal efficiency, which at that time was predetermined by the low compressor pressure ratio, at about 3:1, exacerbating by the low component efficiencies which further deteriorated the thermal efficiency. This, of course, caused high fuel consumption. This was somewhat counterbalanced by the fact that the lower quality kerosene used in gas turbines was more available than petrol at the end of the war, when Germany suffered from lack of fuel.

Another typical problem came from the fact that gas turbines typically work at high RPM. At low engine speeds, their torque is also low. Maintain a relatively narrow high-speed range and provide sufficient torque for the vehicle can be solved only with a complicated transmission and clutch system. The free-turbine (or with other words power-turbine) solution was already present in the first plans but when the load decreases, the overrun of the free-turbine is unmanageable.

Another idea was to drive a generator by the gas turbine shaft power to provide the required electric power for an electric motor. Later this was dropped and GT 101 (Figure 4, left) became a modified version of a BMW 003 aircraft gas turbine engine. The most important change is that the number of turbine stages were increased from one to three, and the extra stages added extra power to the gas generator shaft.⁹ However, the placement of the new power source in the vehicle caused serious problems, the delivered 857 kW shaft power at 450 kg mass was impressive enough comparing to the 462 kW and 1200 kg mass of the Maybach HL230 P30 piston engine. Another advantage was that the relatively heavy

⁹ Gas generator: the core of the gas turbine engine: compressor, combustor, (compressor) turbine.

gas generator rotor (compressor and turbine) operated as a flywheel improving the off-road ability of the vehicle through terrain obstacles.

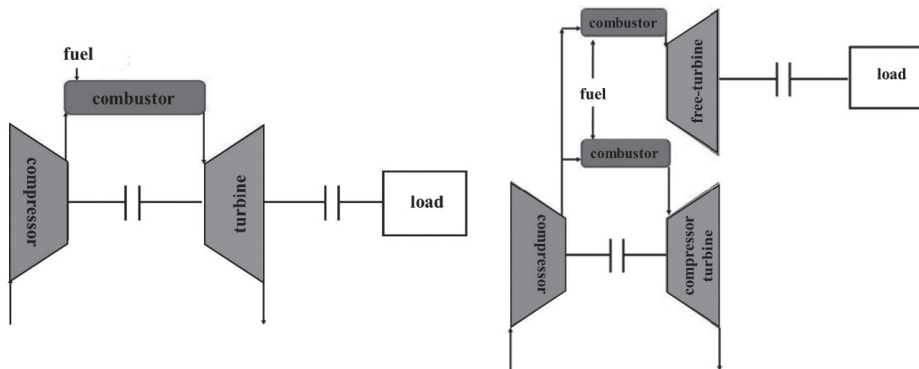

Figure 4. Left: the schematic of GT 101 gas turbine engine with undivided turbine (no free-turbine); right: GT 102 gas turbine engine with extra combustor and free-turbine. [Edited by the author.]

In case of GT 102 engine (Figure 4, right) a completely different concept was followed. The two-stage free-turbine was completely separated from the gas generator unit. Interestingly, it had its own combustor, which was air supplied by the compressor bleed air¹⁰ of the gas generator unit (30% of the total air supply). The over-run of the free-turbine in unloaded state was solved by releasing the working fluid to the surrounding atmosphere.

The GT 103 gas turbine engine was actually the version of the GT 102 with a heat exchanger. The idea was logical as the compressor of these engines had very low compressor pressure ratio and consequently low compressor exit temperature. The temperature of the exiting exhaust gas was much higher and could preheat the compressor air before entering into the combustor, significantly decreasing the fuel consumption. [4]

Although the above-mentioned engines were suitable to install into combat vehicles and preparations were made to do it, but the continuous deterioration of the military situation made it impossible to launch the serial production.

The Adaptation of Shaft Power Producing Gas Turbines in Aviation

In the late 40s and early 50s, turboshafts also appeared in aviation. The first low performance, so-called Auxiliary Power Units (APU) appeared on the board of aircrafts; their task was to start up the main engines of the aircraft, supply the on-board electrical energy system, and supply air to the air conditioning system.

¹⁰ Bleed air is compressed air that is taken from the compressor stage upstream of the combustor.

In the second half of the 1950s, when helicopters achieved their adulthood, and it became an urgent problem to replace the relatively low-power and heavy piston engines, for which the turboshaft engines offered a good alternative. Only some types of light helicopters (e.g. Robinson) are exceptions, in which the piston engine has remained the power source. The first type of gas turbines used in helicopters was the Turbomeca Artouste turboshaft in 1950 (Figure 5), originally intended to use as an auxiliary power unit.

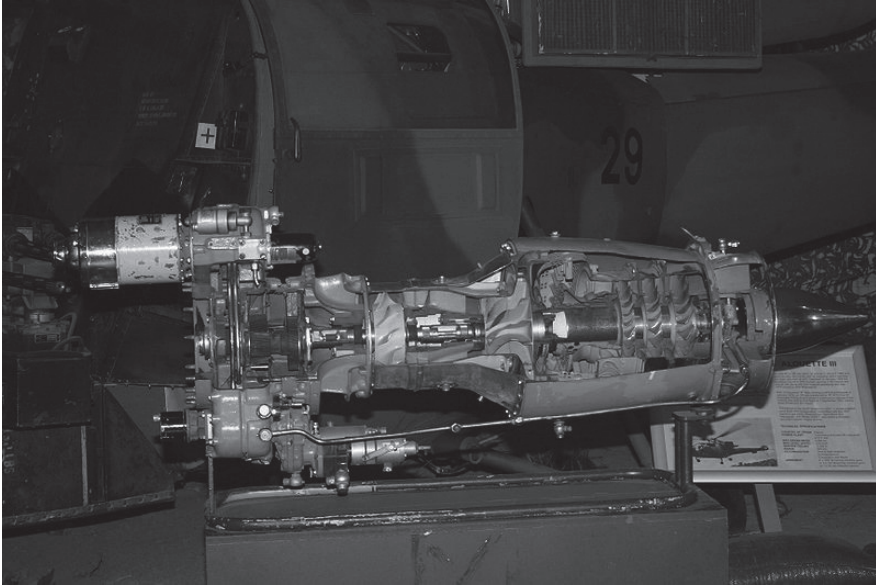

Figure 5. *Turbomeca Artouste, the first turboshaft used in helicopters.* [5]

This engine was capable of up to 210 kW shaft power and was incorporated into a number of helicopters such as Aérospatiale Alouette II, Aérospatiale Alouette III, Aérospatiale Lama, Aerothèque AC-14, Atlas XH-1 Alpha, IAR 317 and aircrafts like Handley Page Victor, Hawker Siddeley Trident, Vickers VC10 as auxiliary power units. [5]

Of course, the great powers did not wait idly and the developments started. In the United States, Lycoming with Anselm Franz, the creator of the Jumo 004 gas turbine engine in Nazi Germany, began to build a 373–522 kW turboprop engine family on behalf of the US Air Force. The T53 and T55 turboshaft engines came from this project. The T53 were built into helicopters or aircrafts such as Bell UH-1 Iroquois and AH-1 Huey Cobra and Grumman OV-1 Mohawk airplane. [7]

It should be noted that there is a considerable structural similarity between turboprop and turboshaft engines. A number of manufacturers produces turboprop and turboshaft variants of a particular type of gas turbine engine. However, there are two fundamental differences between these two categories. One is that in case of turboprops in general (except small turboprop aircrafts) a small portion of the energy of the exhaust gas is converted into thrust in the nozzle, thereby providing 10–15% of the total thrust by the nozzle instead of using additional turbine stage(s) or by modifying the turbine to allow the remaining part of energy to be converted into shaft power. The other difference is that in turboprops the propeller and

the transmission are structurally part of the engine. In case of helicopter turboshafts, the main gearbox is structurally connected to the airframe and the thrust force is transferred directly to the airframe, not to the engine.

In the early 1950s, General Electric also received a \$3 million contract from the Government of the United States to develop a new light-weight, reliable gas turbine engine suitable to use as a helicopter power source. The secret program was launched under the name of XT-58 and the final result was a 596 kW shaft power turboshaft engine (Figure 6); its mass was only 181 kg.

This engine was further developed by 1957 and its output shaft power improved to 783 kW and its mass decreased to 114 kg. This year the piston engine of the Sikorsky HSS-1F helicopter was replaced by two T58 turboshaft engines and became the first US gas turbine powered helicopter. Recognizing the practical importance of the new development, a number of US helicopter manufacturers (Sikorsky, Kaman) built the newly developed T58 engine in their helicopters. [9]

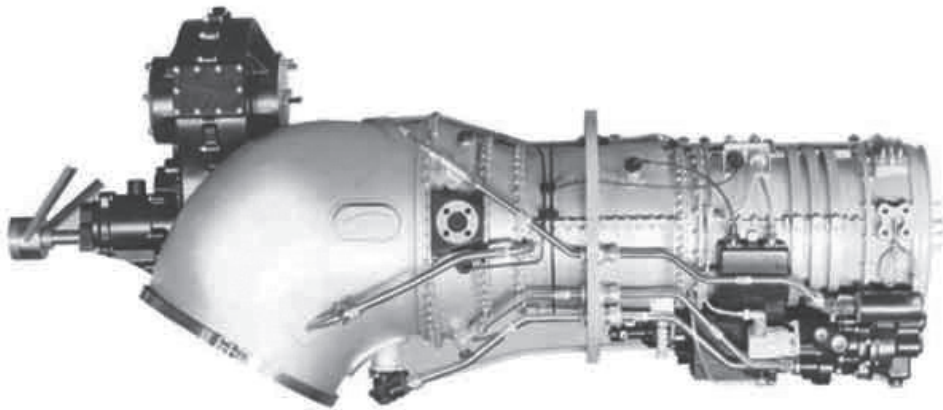

Figure 6. *The XT-58 turboshaft engine is mostly identical with the arrangement used today.* [9]

The first Soviet second-generation helicopters appeared in 1957. This Mi-6 was a heavy transport and a troop carrier helicopter. In the second half of the 50s Mikhail Leontyevich Mil, the head of the Mil design bureau decided to design a revolutionary new helicopter for the replacement of the that time already obsolete Mi-4 helicopters in the medium-size transport helicopter category.

On 20 February 1958, the Council of Ministers of the Soviet Union adopted this proposal and ordered the development of a helicopter capable of carrying 1.5 to 2 tonnes of payload with a V-8 type designation, which would be equipped with an Ivchenko AI-24V turboprop engine modified for use on a single rotor helicopter. The single-engine V-8 helicopter first flew on 24 June 1961. Recognizing the disadvantages of the AI-24V engine, the Izotov Engine Design Bureau was instructed to develop a truly helicopter application optimized gas turbine engine. The TV-2VM and D-25V engines used for Mi-6 were originally designed for fixed wing aircraft. The new TV2-117A turboshaft (Figure 7) and the VR-8 main gearbox

designed by the Izotov Bureau was delivered in the summer of 1962. The new engine produced 1118 kW shaft power at take-off rate of power with relatively good specific parameters. [10]

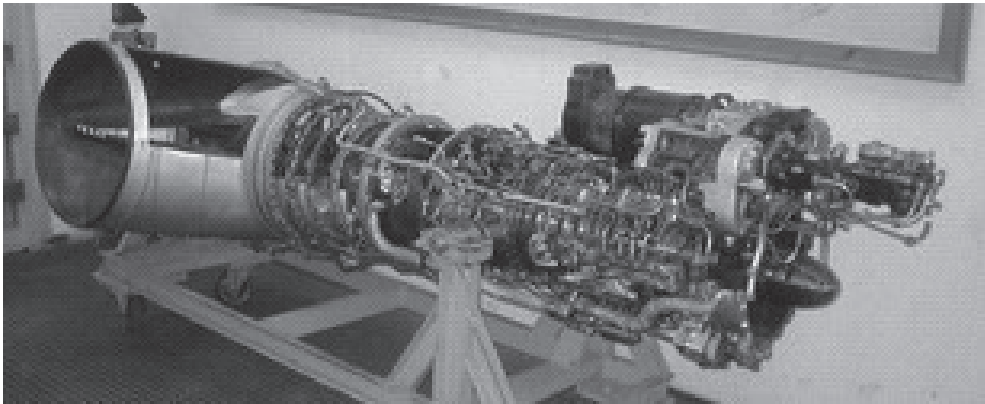

Figure 7. TV2–117A, the first Soviet turboshaft engine designed for helicopter application. [Author's own photo.]

The TV3–117 turboshaft family became the power source of the next-generation Soviet helicopters. Its structural layout is similar to that of the TV2–117A engine, apart from the two additional compressor stages, which provide higher compressor pressure ratio (9.4:1 compared to 6.6:1), and the mass flow rate¹¹ (8.7 kg/s compared to 6.8 kg/s) providing higher shaft power (1640 kW compared to 1108 kW). These engines were used in almost all Russian medium-size transport and attack helicopters: Mi–SMT, Mi–17, Mi–14, Mi–24, Mi–25, Mi–35, Mi–28, Ka–27, Ka–28, Ka–29, Ka–31, Ka–32, Ka–50 and Ka–52, demonstrating their reliability. [6]

Of course, the urgent claim for these new engines was soon to be targeted by most engine manufacturers and today 10–12 of them dominate this segment of the market. The number of their types and their modifications is almost uncountable. They can be found in Reference [7] (and Annex 1) where we can track the most important manufacturers, their products and the most important parameters of their engines.

In this period the classical principle of this gas turbine category (Figure 8), which was mostly embodied in the free-turbine application, became quite common. The so-called gas generator rotor (compressor and compressor turbine) is not mechanically connected to the free-turbine, which allows independent free-turbine speed from the gas generator unit speed. Accordingly, the free-turbine has only gas dynamical connection with the gas generator unit, i.e. the residual energy of the hot gas is utilized in the free turbine, ensuring the required shaft power.

¹¹ Mass flow rate: amount of air flows through the engine per second (kg/s).

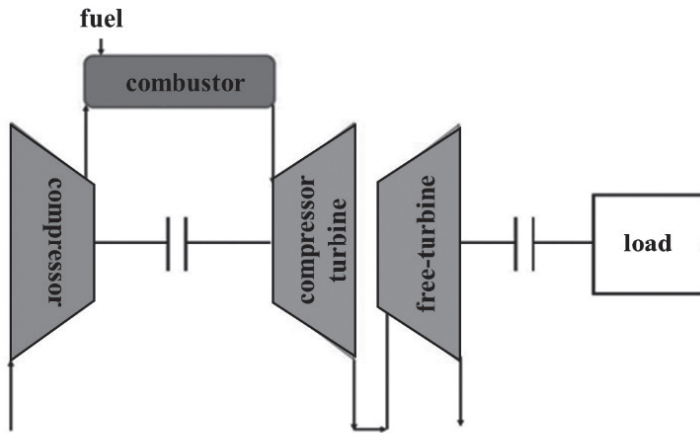
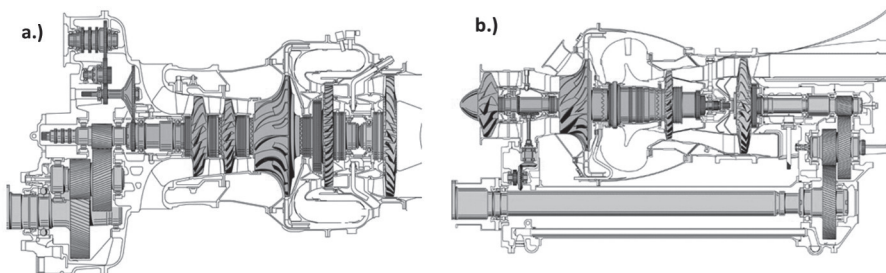

Figure 8. *The schematic of turboshafts used today.* [Edited by the author.]

Though the principle has not changed since the 1950s, helicopter turboshafts have undergone through significant development. The layout has changed as the reverse-flow combustor became more common (Figure 9/a; d), some of the turbine stages were incorporated into the ring-like inner combustor case (Figure 9/a; d). In many cases, a front drive is used (Figure 9/a; c), so that the first reduction gear stage would remain part of the engine itself (Figure 9/a; b). As a result, the engines became more compact and lighter. Their specific parameters and thermal efficiency has improved despite the fact that the aforementioned structural changes often had a negative effect on their component efficiencies and through it on their thermal efficiency. In Figure 9/a; b; c the gas generator (blue) and the free-turbine (brown) is clearly divided, which is shown by their different colour.

The RTM 322 engine schematics, shown in Figure 9/d, illustrates one of the most typical structural solutions. The compressor's 3–5 axial stages are followed by a centrifugal compressor stage mounted on the same shaft. The reason for using a centrifugal stage is that it can replace 4–5 axial stages.



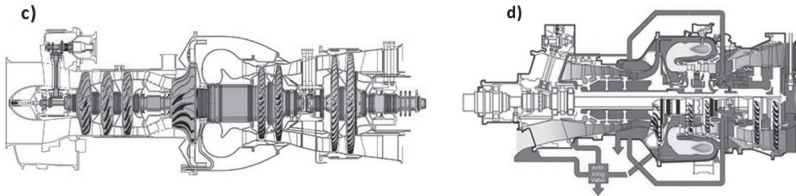

Figure 9. *Schematics of different turboshaft arrangements.* [11]

This solution reduces the length of the engine. On the other hand, though the centrifugal compressor usually has a lower polytropic efficiency than the axial compressor, but due to the low air mass flow rate, the short blade length of the last axial compressor stage would produce an even worse polytropic efficiency than the centrifugal compressor. The reverse flow combustor also reduces the length of the engine, although it slightly increases the combustor pressure loss. The turbine blades are cooled in the first stages, though the turbine inlet temperature is lower than in other gas turbine categories. Free-turbine blades are generally not, or only minimally cooled. The exhaust pipe system serves only to allow the exhaust gas into the surrounding atmosphere.

Figure 10 also depicts a modern helicopter turboshaft engine, which is the product of the MTR consortium and doubly built in, powers the Eurocopter Tiger helicopter.

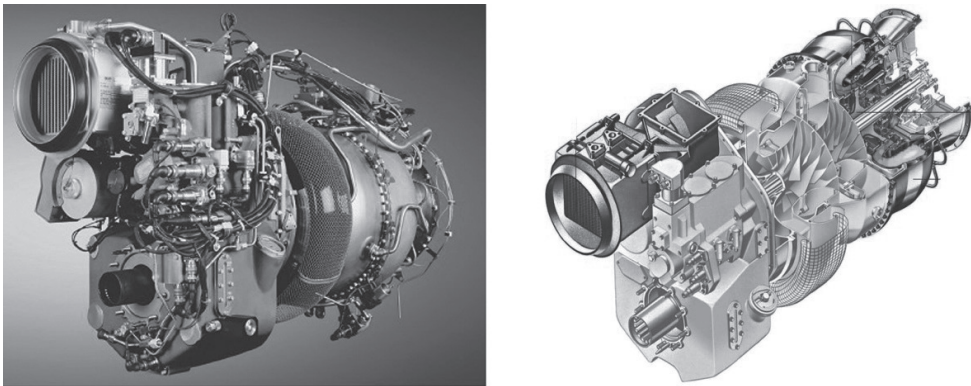

Figure 10. *MTR 390, the power source of Eurocopter Tiger.* [12]

Compared to the previous layouts, its novelty is that even the first axial stages are replaced with a centrifugal stage. This provides an even shorter and compact layout, reduces the tendency of compressor stall,¹² and achieves a satisfactory compressor and turbine efficiency at low air mass flow rate. Table 2 illustrates the performance, mass and size data of the two variants.

¹² Compressor stall: the flow separation in the compressor due to the deformed velocity triangles.

Table 2. *Most important data of two MTR 390 engine variants.* [12]

MTR 390 engine variants Uninstalled, ISA¹³ H = 0 m	MTR 390–2C	MTR 390–E
Measure of the rate of power (kW)	958	1094
Emergency power (30s) (kW)	1160	1322
Maximum continuous power (kW)	873	1000
Specific fuel consumption (take off) (kg/kWh]	0.284	<0.299
Specific fuel consumption (max. cont.) (kg/kWh)	0.280	<0.293
Air mass flow rate (take off) (kg/s)	3.2	3.6
Compressor pressure ratio (take off)	13	14
Free turbine RPM (1/min)	8320	8320
Length (mm)	1078	1078
Width (mm)	442	442
Height (mm)	682	682
Mass (kg)	169	<179

Statistical Analysis of Helicopter Turboshaft Engines

When we examine the development of the category, of course we have to consider many factors. These include specific fuel consumption (ratio of fuel consumption to shaft power), specific net work output (ratio of shaft power to air mass flow rate), specific power (ratio of shaft power to engine mass), reliability, operability, which of course affect the tactical-technical operation of helicopters.

Diagrams from Figure 11 to 14 display the different engine performance features as a function of shaft power processing the Annex 1 with Excel function manager. What is apparent at first sight in Figure 11 is that in terms of engine shaft power, the helicopter engines can be divided into three distinct categories by their shaft power, with some well-perceived gaps among them. The smallest performance category provides up to 200–800 kW take off power. The medium performance category includes power plants ranging from 1000 to 2200 kW, while in the large category there are 2500–3700 kW shaft power outputs. Obviously, this latter category of my analysis contains the fewest pieces. This does not mean that there are only that many engines in this category but due to the relatively small number of *heavy* transport helicopter types and the relatively low production number, the choice is not so numerous like in small and medium categories.

Of course, in some cases, we can find some data out of the aforementioned interval. The T64–GE–100's 3228 kW performance and 13.3 kg/s air mass flow rate is high, but it is also dwarfed by the Mi-26 helicopter's D–136 engine with 8501 kW output. Due to its relatively high air consumption, its specific fuel consumption is also quite good (0.266 kg/kWh).

¹³ ISA—International Standard Atmosphere.

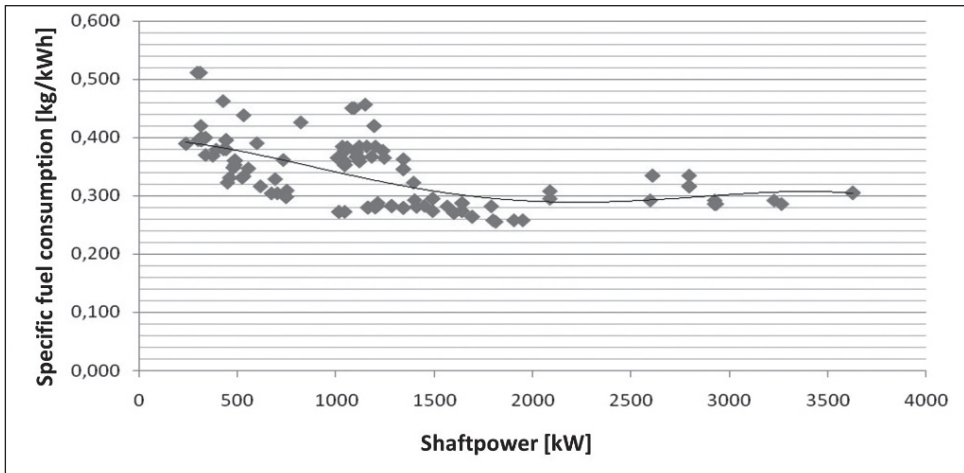

Figure 11. *Specific fuel consumption vs. shaft power diagram.* [Edited by the author.]

However, in the low shaft power category we can also meet specific fuel consumption values around 0.5 kg/kWh. For example, the Mi-2 helicopter’s GTD 350, which is well-known in our practice, has a 0.489 kg/kWh specific fuel consumption which is extremely high. This can be explained by the age and relatively small size of the engine. In most cases the available data for the analysis is the specific fuel consumption, but this can easily be converted into thermal efficiency using Equation 1 and 2.

$$\eta_{th} = \frac{P[W]}{\dot{Q}_{in} \left[\frac{J}{s} \right]} = \frac{P[W]}{\dot{m}_{fuel} \left[\frac{kg}{s} \right] \cdot FHV \left[\frac{J}{kg} \right]} \quad \text{míg a} \quad SFC = \frac{3600 \cdot \dot{m}_{fuel} \left[\frac{kg}{s} \right]}{P[kW]} \left[\frac{kg}{kWh} \right] \quad 1.$$

$$\eta_{th} = \frac{1}{\frac{SFC \left[\frac{kg}{kWh} \right]}{3600 \left[\frac{kWs}{kWh} \right]} \cdot FHV \left[\frac{kJ}{kg} \right]} = \frac{3600}{FHV \cdot 43217,08} [-] \quad 2.$$

Where:

- η_{th} : thermal efficiency [-];
- P: shaft power (kW);
- \dot{Q}_{in} input heat flow (J/s);
- \dot{m}_{fuel} fuel mass flow rate (kg/s);
- FHV: fuel heating value (J/kg);
- SFC: specific fuel consumption (kg/kWh).

Of course, Equation 2 gives the correct result if the specific fuel consumption is replaced by kg/kWh according to the derivation. For the conversion, the fuel heating value is still requested. Here, the standard 18,580 BTU/lb was adopted from the Boeing’s *Jet Fuel Characteristics* workbook, which corresponds to 43,217,080 J/kg after the unit conversion. [8]

If we examine the diagram in Figure 11, it is interesting to note the nature of the average specific fuel consumption vs. shaft power curve. Considerable change can be seen at higher shaft power. The average specific fuel consumption decreases from about 0.4 kg/kWh to 0.3 kg/kWh. Converting them to thermal efficiency, the related efficiencies are 21% (0.4 kg/kWh) and 28% (0.3 kg/kWh) giving a considerable difference.

This, of course, is only indirectly related to shaft power. The real reason is that generally higher shaft power needs larger geometric dimensions, which results in better component efficiencies (compressor, combustor, turbine efficiencies, for example due to the relative smaller blade tip clearances). This is even more true if the maximum air consumption is at least 30 kg/s or so like in turbofans. Nowadays their thermal efficiency is well above 40% at maximum rate of power. At the same time in case of helicopter engines, thermal efficiency around 30% is reasonable. We can conclude, that the thermal efficiency of helicopter turboshafts is generally between 17% and 32%. Worse thermal efficiency (higher specific fuel consumption) is expected at smaller and (or) older engines. Of course, differences in technological levels among individual manufacturers may also appear in efficiency, but the technological gap is less and less present in today’s globalizing world. According to the company data, RTM 322–04/08, RTM 322–01/9 and RTM 322–01/9A nowadays represent the best specific fuel consumption (0.258 kg/kWh), which results in slightly more than 30% thermal efficiency.

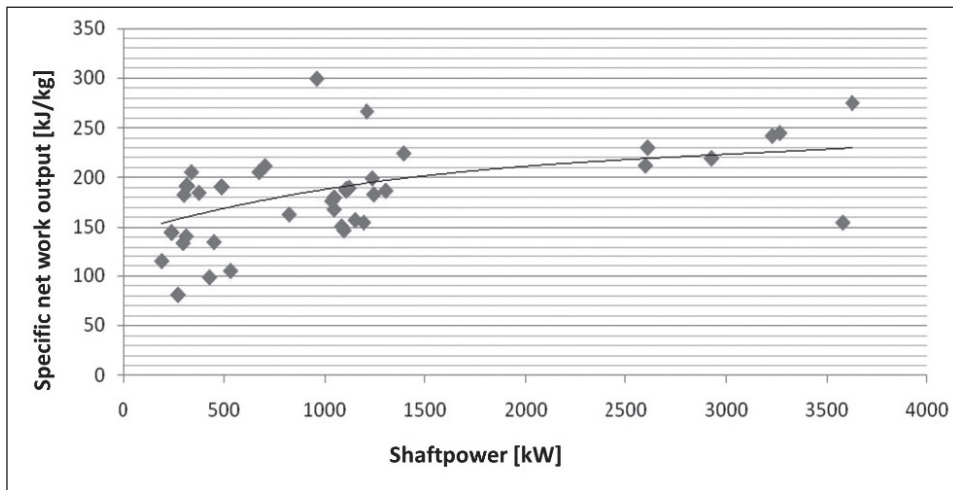

Figure 12. *Specific net work output vs. shaft power diagram.* [Edited by the author.]

The next important quality indicator of turboshafts is the specific net work output (Figure 12). This indicator has a close relationship with the geometric dimensions and mass of the engine. The specific net work output of the engine is higher if smaller mass flow rate is required to generate the same shaft power, reducing the size and consequently

the mass of the engine. The situation is the same as it was concerning thermal efficiency. Engines with higher shaft power (larger engines) produce better specific net work output. Considering the trend line, the difference is almost 100 kJ/kg, but there are engines from 100 kJ/kg to 300 kJ/kg specific net work output.

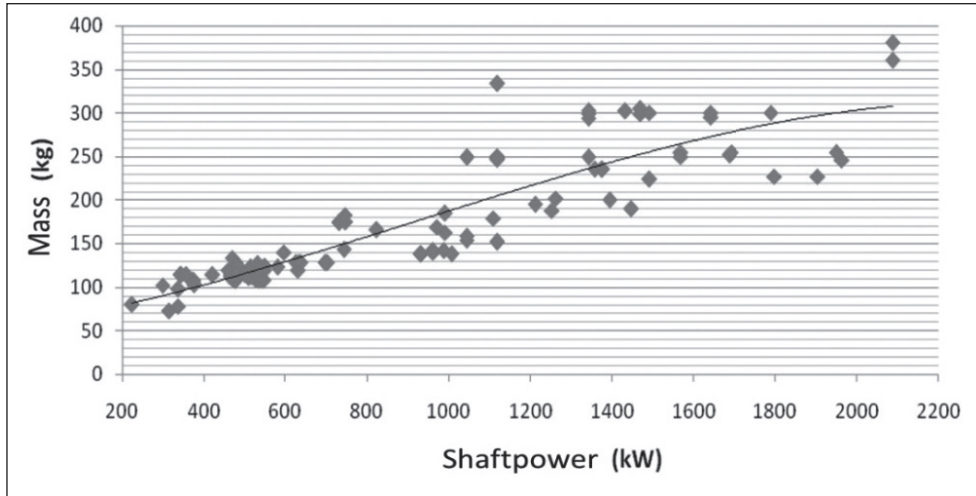

Figure 13. *Specific power vs. shaft power diagram.* [Edited by the author.]

In Figure 13 the engine mass versus shaft power is displayed which generally ranges from at about 80 kg to 300 kg. This information is not surprising because it is clear that higher shaft power needs larger and heavier engine. The next diagram in Figure 14 is more informative. This diagram represents the shaft power to mass ratio (specific power) of turboshaft engines, which also enables the comparison of one design to another. Like in previous cases the larger size provides better values. The average specific power ranges from 3 kW/kg to 7 kW/kg, but there are engines with 8kW/kg specific power, which is quite excellent.

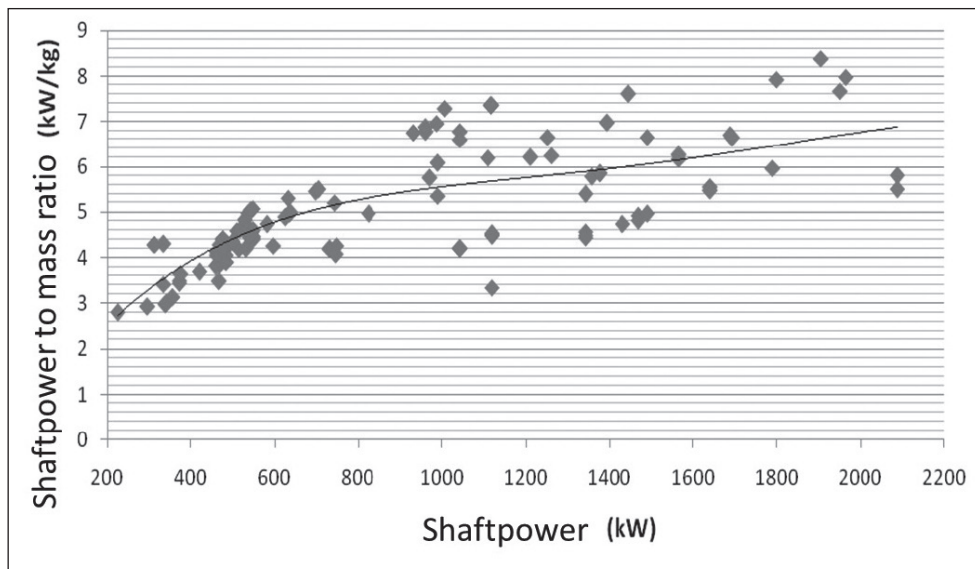

Figure 14. *Specific power vs. shaft power diagram.* [Edited by the author.]

The most important results of this computer aided processing of engine data are that it clearly displays the size dependence of these engine parameters. Even the largest engines in this category are small comparing them, for example, to turbofans. This fact predetermines the relatively weak values of their specific parameters, like specific fuel consumption, specific net work output and specific power, which are in fact important quality indicators. Inside the category, this trend significantly appears in Figure 11, 12 and 14. In accordance with this, it is misconducting to compare turboshaft engines by these indicators to other gas turbine engine categories, what is more even inside the category if their shaft power is not quite close to each other.

We can ask the question: does size really matter? The answer for the question is obvious. The size is extremely important considering these indicators. We can firmly state that the helicopter turboshaft category is penalised by its own small size and inside the category this size dependence is even more clear.

Summarizing the essence of this statistics, usually we can find the following turboshaft engine data:

shaft power:	200–3700 kW
compressor pressure ratio:	7:1–16:1
mass flow rate:	2–15 kg/s
turbine inlet temperature:	1100–1500 K
specific fuel consumption:	0.25–0.5 kg/kWh
thermal efficiency:	17–32%
engine mass:	80–400 kg
specific power:	3–8 kW/kg

Conclusions

The leading military powers began to use helicopters in the early fifties. The experiences of local wars (Korea, Algeria, Vietnam, Middle East, etc.) offered newer and newer areas of their application and contributed to their specialization and the rapid growth of their number. Within a few years, due to the increasing take-off mass and payload, helicopters outgrew the available piston engines and the only alternative was a lightweight, high-performance power source that the turboshaft engines are perfectly suited for.

Of course, over the past 60 years, many improvements and innovations have changed dramatically the turboshaft category. The increased compressor pressure ratio, turbine inlet temperature, the FADEC¹⁴ system highly improved their performance, while the long-term reliability and maintainability has also increased. Nonetheless, some indicators of helicopter turboshaft engines, like thermal efficiency and all specific parameters are significantly worse than the average of other gas turbine engine categories. Unfortunately, there is not much to do with this fact, because it is coded in their relatively small size and their structural arrangement.

References

- [1] *The Messerschmitt Bf 109*. www.chuckhawks.com/me-109.htm (Downloaded: 02.02.2018)
- [2] *Whittle Jet Engine W2-700*. http://it.wikipedia.org/wiki/File:Whittle_Jet_Engine_W2-700.JPG (Downloaded: 02.02.2018)
- [3] *Jendrassik György*. www.sztnh.gov.hu/feltalalok/jendrass.html (Downloaded: 02.02.2018)
- [4] *GT 101*. http://en.wikipedia.org/wiki/GT_101 (Downloaded: 15.01.2018)
- [5] *Turbomeca Artouste*. http://en.wikipedia.org/wiki/Turbomeca_Artouste (Downloaded: 02.02.2018)
- [6] *Turboshaft Engine TV3-117*. www.vkms.ru/production_en.shtml (Downloaded: 02.03.2013)
- [7] Engine Manufacturers. *Helicopter Annual*, (2009), 57–63. <https://slidex.tips/download/rolls-royce-turbomeca-ltd-andy-upton-marketing-manager-rtm322-4-grosvenor-place> (Downloaded: 14.02.2018)
- [8] LAWICKI, D.: *Jet Fuel Characteristics, Boeing, 2002*. www.docstoc.com/docs/7654823/JET-FUEL-FACTS (Downloaded: 02.03.2013)
- [9] *GE Aviation*. www.geaviation.com/engines/military/t58/ (Downloaded: 02.03.2013)
- [10] *Klimov*. <http://en.klimov.ru/production/helicopter/TV2-117/> (Downloaded: 15.03.2013)
- [11] *Rolls-Royce*. www.rolls-royce.com/Images/RTM_322_tcm92-6703.pdf (Downloaded: 10.02.2013)
- [12] *MTU Aero Engines*. www.mtu.de/engines/military-aircraft-engines/helicopters/mtr390/ (Downloaded: 02.02.2018)

¹⁴ FADEC—Full Authority Digital Engine Control

Annex 1/1. Most important manufacturers, types, technical data. [7] (N/A: no data)

Manufacturer	Type of the engine	Helicopter, in which the engine is built in	Take off power(kW)	Max continuous (kW)	Specific fuel consumption (kg/kWh)	Thermal efficiency (%)	Mass (kg)
General Electric	T58-GE-1	CH-3B/C, SH-3A, S-61A	962	N/A	N/A	N/A	142
General Electric	T58-GE-2	AB204AS	988	N/A	N/A	N/A	142
General Electric	T58-GE-3	TH-1F, UH-1F/P	962	N/A	N/A	N/A	140
General Electric	T58-GE-5	CH-3E, HH-3E/F, SH-3E/F	1118	N/A	0.365	22.8	152
General Electric	T58-GE-6	CH-46A	932	N/A	N/A	N/A	138
General Electric	T58-GE-8B	SH-2F, SH-3G, UH-2A/B/C, CH-113A	932	N/A	N/A	N/A	138
General Electric	T58-GE-8F	SH-2F, SH-3G, UH-2C, CH-124A/B	1007	N/A	0.365	22.8	138
General Electric	T58-GE-10	CH-46D/F, UH-46D/F, HH-2D, HH-3F, SH-3D/G/H, ASH-3A/D/TS, AS-61R	1044	N/A	0.377	22.1	158
General Electric	T58-GE-16	CH-46E	1394	N/A	0.322	25.9	200
General Electric	T58-GE-100	ASH-3H, CH-124A/B Sea King	1118	N/A	N/A	N/A	152
General Electric	T58-GE-402	CH-46D/E, SH-3H, UH-3H	1118	N/A	N/A	N/A	152
General Electric	T64-GE-1	CH-53A	2297	N/A	N/A	N/A	N/A
General Electric	T64-GE-3	HH-53B	2297	N/A	N/A	N/A	N/A
General Electric	T64-GE-6	CH-53A, TH-53A	2125	N/A	N/A	N/A	N/A
General Electric	T64-GE-7	CH-53C, HH-53B/C/H	2926	N/A	N/A	N/A	N/A

Manufacturer	Type of the engine	Helicopter, in which the engine is built in	Take off power(kW)	Max continuous (kW)	Specific fuel consumption (kg/kWh)	Thermal efficiency (%)	Mass (kg)
Honeywell Defense and Space	HTS900	Bell ARH (1)	744	664	0.320	26.0	143
Honeywell Engines & Systems	AL5512	BV234 & BV-234LR (2)	3039	2218	0.330	25.2	354
Honeywell Engines & Systems	LTS101-600A-3A	Eurocopter AS350B (1) Eurocopter AS350D (1) Eurocopter AS350A (1)	485	466	0.347	24.0	120
Honeywell Engines & Systems	LTS101-650B-1	Eurocopter BK-117A (2)	470	418	0.347	24.0	122
Honeywell Engines & Systems	LTS101-750C-1	Bell 222B, UT (2)	510	487	0.353	23.6	111
Honeywell Engines & Systems	LTS101-750B-2	Eurocopter/U.S. Coast Guard HH-65A (2)	515	491	0.347	24.0	123
Honeywell Engines & Systems	LTS101-750B-1	Eurocopter BK-117B (2)	468	440	0.353	23.6	134
Honeywell Engines & Systems	LTS101-850B-2	Eurocopter HH-65A (2)	582	556	0.347	24.0	123
Honeywell Engines & Systems	LTS101-700D-2	Eurocopter AS350B2	546	485	0.347	24.0	120
Honeywell Engines & Systems	LTS101-650C-3	Bell 222 (2)	470	446	0.347	24.0	110
Honeywell Engines & Systems	LTS101-600A-2/-3	Eurocopter AS350D (1)	459	440	0.347	24.0	120
Honeywell Engines & Systems	T55-L-712	CH-47D (2)	2796	2237	0.322	25.9	354

B. VARGA: Power Sources of Military Helicopters

Manufacturer	Type of the engine	Helicopter, in which the engine is built in	Take off power(kW)	Max continuous (kW)	Specific fuel consumption (kg/kWh)	Thermal efficiency (%)	Mass (kg)
Honeywell Engines & Systems	T55-L-712F	HCMK2/2A (2)	3218	2349	0.319	26.1	354
Honeywell Engines & Systems	T55-L-712 S/SB	CH-47D (2)	3262	2349	0.315	26.4	354
Honeywell Engines & Systems	T55-L-712E	CH-47 (2)	2796	2237	0.322	25.9	354
Honeywell Engines & Systems	T55-L-712 S/SC	CH-47D (2)	2796	2237	0.322	25.9	354
Honeywell Engines & Systems	T55-L-714A	CH-47S/D & HCMK3 (2)	3629	3108	0.316	26.4	399
Honeywell Engines & Systems	T55-L-714	MH-47E (2)	3562	3069	0.312	26.7	399
Honeywell Engines & Systems	T55-GA-714A	CH-47D/F (2)	3562	3069	0.312	26.7	399
Honeywell Engines & Systems	T5313B	Bell 205A1, Bell 205B	1044	932	0.365	22.8	249

Annex 1/2. Most important manufacturers, types, technical data. [7]

Manufacturer	Type of the engine	Helicopter, in which the engine is built in	Take off power (kW)	Max continuous (kW)	Specific fuel consumption (kg/kWh)	Thermal efficiency (%)	Mass (kg)
Honeywell Engines & Systems	T5317B	Bell 205A1, Fuji Bell 205B	1119	1007	0.367	22.6	250
Honeywell Engines & Systems	T5317BCV	B210, Huey II, Bell 205	1342	1119	0.346	24.0	249
Honeywell Engines & Systems	T53-L-13B	Bell UH-1, Agusta AB205	1044	932	0.365	22.8	249
Honeywell Engines & Systems	T53-L-703	Bell AH-1, Bell UH II	1119	1007	0.395	21.0	247
LHTEC	CTS800-4N	AgustaWestland Super lynx (2) AgustaWestland/Turkey T129 (2)	991	920	0.28	29.7	185
LHTEC	CTS800-4K	Shimaywa US2 (1)	991	920	0.28	29.7	163
MTR	MTR 390-2C	Eurocopter Tiger (2)	972	885	0.276	30.1	169
MTRI	MTR 390-E	Eurocopter Tiger (2)	1110	1009	0.288	28.9	179
Pratt & Whitney Canada	PT6B-36A	Sikorsky S-76B (2)	732	661	0.353	23.5	174
Pratt & Whitney Canada	PT6B-36B	Sikorsky S-76B (2)	732	661	0.353	23.5	175
Pratt & Whitney Canada	PT6B-37A	Agusta A119 Koala (1)	747	650	0.361	23.0	175
Pratt & Whitney Canada	PT6C-67A	Bell Agusta BA609 (2)	1447	1249	N/A	N/A	190
Pratt & Whitney Canada	PT6C-67C	Agusta AW139 (2)	1252	1142	0.308	27.0	188
Pratt & Whitney Canada	PT6C-67D	(UH-1H) DynCorp Global Eagle (1)	1262	1182	0.308	27.0	202

Manufacturer	Type of the engine	Helicopter, in which the engine is built in	Take off power (kW)	Max continuous (kW)	Specific fuel consumption (kg/kWh)	Thermal efficiency (%)	Mass (kg)
Pratt & Whitney Canada	PT6C-67E	EC175	1324	N/A	N/A	N/A	N/A
Pratt & Whitney Canada	PT6T-3 TwinPac ®	Bell UH-1N, Bell CUH-1N, Bell VH-1N, Bell AH-1J, Bell AH-1T, Bell/Agusta-Bell 212, Sikorsky S-58T	1342	1193	0.362	23.0	294
Pratt & Whitney Canada	PT6T-3B/BF TwinPac ®	Bell/Agusta-Bell 212 Bell/Agusta-Bell 412 Bell/Agusta-Bell 412SP (1)	1342	1193	0.365	0.228	299
Pratt & Whitney Canada	PT6T-3BE/BG TwinPac ®	Bell 412 HP, Agusta-Bell 412 Agusta-Bell 412 HP (1)	1342	1193	0.365	22.8	302
Pratt & Whitney Canada	PT6T-3D/DE/ DF TwinPac ®	Bell/Agusta-Bell 412 EP (1)	1432	1268	0.365	22.8	302
Pratt & Whitney Canada	PT6T-6 TwinPac ®	Agusta-Bell 212/412 Sikorsky S-58T (1)	1469	1301	0.36	23.1	299
Pratt & Whitney Canada	PT6T-6B TwinPac ®	Agusta-Bell 412 HP (1)*	1469	1301	0.36	23.1	305
Pratt & Whitney Canada	PW206A	MD Explorer	477	423	N/A	N/A	108
Pratt & Whitney Canada	PW206B	EC135P1	463	419	N/A	N/A	112
Pratt & Whitney Canada	PW206B2	EC135P2	518	457	N/A	N/A	112
Pratt & Whitney Canada	PW206C	Agusta A109Power (2)	477	423	N/A	N/A	108
Pratt & Whitney Canada	PW206E	MD Explorer	477	423	N/A	N/A	108
Pratt & Whitney Canada	PW207C	Agusta A109 Grand (2)	548	466	N/A	N/A	108

Annex 1/3. Most important manufacturers, types, technical data. [7]

Manufacturer	Type of the engine	Helicopter, in which the engine is built in	Take off power (kW)	Max continuous (kW)	Specific fuel consumption (kg/kWh)	Thermal efficiency (%)	Mass (kg)
Pratt & Whitney Canada	PW207D	Bell M427 (2)	529	466	N/A	N/A	110
Pratt & Whitney Canada	PW207D1	Bell 429 (2)	536	474	N/A	N/A	108
Pratt & Whitney Canada	PW207E	MD Explorer (2)	529	466	N/A	N/A	109
Pratt & Whitney Canada	PW207K	Kazan Ansat (2)	544	466	N/A	N/A	108
Pratt & Whitney Canada	PW210S	Sikorsky S-76D (2)	802	802	N/A	N/A	N/A
Rolls-Royce	RR 300	Robinson R66 (1)	224	179	0.408	20.4	80
Rolls-Royce	RR 500TP	Under development	298	283	0.335	24.9	102
Rolls-Royce	Model 250-C20B	Agusta A109A (2).Bell 206B JetRanger (1). Bell 206L LongRanger (1).Eurocopter BO105 (2). Hiller FH1100 (1) MD Helicopters MD500D (1)	313	313	0.395	21.1	73
Rolls-Royce	Model 250-C20F	Eurocopter AS355F (2)	313	313	0.395	21.1	73
Rolls-Royce	Model 250-C20J	Bell 206B JetRanger III (1) Bell TH-57 (1) Bell TH-67 (1)	313	313	0.395	21.1	73

Manufacturer	Type of the engine	Helicopter, in which the engine is built in	Take off power (kW)	Max continuous (kW)	Specific fuel consumption (kg/kWh)	Thermal efficiency (%)	Mass (kg)
Rolls-Royce	Model 250-C20R	Agusta A109C (2) Bell 206B JetRanger III (1) HeliLynx 355FX (2) Starflex 355F2 (2) Kamov Ka-226 (2) MD Helicopters MD500E (1) MD Helicopters MD520N (1) PZL SW-4 (1) Tridair Gemini ST (2)	336	336	0.370	22.5	78
Rolls-Royce	Model 250-C20W	Enstrom 480B (1) Northrop Grumman Fire-Scout (1) Schweizer 330SP/333 (1)	313	313	0.395	21.1	73
Rolls-Royce	Model 250-C28	Eurocopter BO 105LS (2)	373	373	0.359	23.2	107
Rolls-Royce	Model 250-C28B	Bell 206L-1 LongRanger II (1)	373	373	0.359	23.2	108
Rolls-Royce	Model 250-C30	MD Helicopters MD530F (1)	485	415	0.360	23.1	114
Rolls-Royce	Model 250-C30G	Bell 230 (2)	485	415	0.360	23.1	115
Rolls-Royce	Model 250-C30M	Soloy AS350 AllStar(1)	485	415	0.360	23.1	114
Rolls-Royce	Model 250-C30P	Bell 206L-3 LongRanger III (1) Bell 206L-4 LongRanger IV (1)	485	415	0.360	23.1	114

Manufacturer	Type of the engine	Helicopter, in which the engine is built in	Take off power (kW)	Max continuous (kW)	Specific fuel consumption (kg/kWh)	Thermal efficiency (%)	Mass (kg)
Rolls-Royce	Model 250–C30R/3	Bell OH–58D (1) Boeing Little Bird ULB (1) MD Helicopters AH/MH–6 (1)	485	415	0.360	23.1	124
Rolls-Royce	Model 250–C30S	Sikorsky S–76A (2)	485	415	0.360	23.1	114
Rolls-Royce	Model 250–C40	Bell 430 (2)	533	457	0.349	23.9	127
Rolls-Royce	Model 250–C47B/M	Bell 407 (1) MD Helicopter MD 600N (1)	485	447	0.355	23.4	124
Rolls-Royce	Gem 42–1	Agusta Westland Lynx (2) Agusta Westland A129 Mangusta (2)	746	664	0.310	26.8	183
Rolls-Royce	Model 250–B17F	Groen Brothers Aviation Hawk 4 (1) O&N Silver Eagle (1) Soloy Cessna 206 'Mark II' (1)	336	336	0.373	22.3	98

Annex 1/4. Most important manufacturers, types, technical data. [7]

Manufacturer	Type of the engine	Helicopter, in which the engine is built in	Take off power (kW)	Max continuous (kW)	Specific fuel consumption (kg/kWh)	Thermal efficiency (%)	Mass (kg)
Rolls-Royce Turbomeca	RTM 322–01/8	Agusta Westland Merlin HC HM Mk1	1567	1374	0.276	30.2	254
Rolls-Royce Turbomeca	RTM 322–01/12	Agusta Westland Apache AH Mk1 (WAH64)	1567	1374	0.276	30.2	250

Manufacturer	Type of the engine	Helicopter, in which the engine is built in	Take off power (kW)	Max continuous (kW)	Specific fuel consumption (kg/kWh)	Thermal efficiency (%)	Mass (kg)
Rolls-Royce Turbomeca	RTM 322–02/8	AgustaWestland Merlin HC Mk3	1688	1406	0.276	30.2	252
Rolls-Royce Turbomeca	RTM 322 Mk250	AgustaWestland Merlin HC Mk3	1693	1491	0.276	30.2	255
Rolls-Royce Turbomeca	RTM 322–04/08	AgustaWestland EH101	1950	1555	0.258	32.3	254
Rolls-Royce Turbomeca	RTM 322–01/9	NHI NH90 (2)	1799	1664	0.258	32.3	227
Rolls-Royce Turbomeca	RTM 322–01/9A	NHI NH90 (2)	1905	1805	0.258	32.3	227
Rolls-Royce	AE 1007	Bell–Boeing V22 Osprey (2)	4549	3253	0.259	32.1	440
Turbomeca	Arrius 1A	Eurocopter AS 355 N (2)	340	296	0.338	24.7	114
Turbomeca	Arrius 1A1	Eurocopter AS 355 NP (2)	343	305	0.338	24.7	114
Turbomeca	Arrius 1M	Eurocopter AS 555 N (2)	357	303	0.338	24.7	114
Turbomeca	Arrius 2F	Eurocopter EC120 (1)	376	336	0.338	24.7	103
Turbomeca	Arrius 2B1	Eurocopter EC135 t1 (2)	421	348	0.320	26.0	114
Turbomeca	Arrius 2B1A–1	Eurocopter EC135 t1 (2)	463	414	0.320	26.0	114
Turbomeca	Arrius 2B2	Eurocopter EC135 t2i (2)	485	438	0.328	25.4	114
Turbomeca	Arrius 2K1	Agusta A109 Power (2)	500	425	0.320	26.0	115
Turbomeca	Arrius 2K2	Agusta A109 LUH (2)	534	454	0.321	26.0	115
Turbomeca	Arrius 2G1	Ka 226t (2)	537	427	N/A	N/A	115
Turbomeca	Arriel 1B	Eurocopter AS 350 BA (1)	478	441	0.362	23.0	114
Turbomeca	Arriel 1D	Eurocopter AS 350 B1 (1)	510	450	N/A	N/A	N/A
Turbomeca	Arriel 1D1	Eurocopter AS 350 B2 (1)	546	466	0.352	23.6	122

Manufacturer	Type of the engine	Helicopter, in which the engine is built in	Take off power (kW)	Max continuous (kW)	Specific fuel consumption (kg/kWh)	Thermal efficiency (%)	Mass (kg)
Turbomeca	Arriel 1C2	Eurocopter AS 365 2 (2)	550	471	0.349	23.9	119
Turbomeca	Arriel 1M1	Eurocopter AS 565 Panther (2)	558	487	N/A	N/A	N/A
Turbomeca	Arriel 1E2	Eurocopter EC 145	550	516	0.349	23.9	125
Turbomeca	Arriel 1K2	Agusta A 109 K	550	471	0.349	23.9	123
Turbomeca	Arriel 1S1	Sikorsky S76 A++	539	466	0.345	24.1	121
Turbomeca	Arriel 2B1	Eurocopter AS350 B3(1)/EC 130B4	632	544	0.333	25.0	119
Turbomeca	Arriel 2C	Eurocopter AS 365 N3	635	597	0.333	25.0	128
Turbomeca	Arriel 2C2CG	Eurocopter HH65C (2)	697	474	N/A	N/A	128

Annex 1/5. Most important manufacturers, types, technical data. [7]

Manufacturer	Type of the engine	Helicopter, in which the engine is built in	Take off power (kW)	Max continuous (kW)	Specific fuel consumption (kg/kWh)	Thermal efficiency (%)	Mass (kg)
Turbomeca	Arriel 2C1	Eurocopter EC155 B	626	596	0.334	24.9	128
Turbomeca	Arriel 2S1	Sikorsky S76 C+	638	587	0.329	25.4	128
Turbomeca	Arriel 2S2	Sikorsky S76 C++	688	621	N/A	N/A	N/A
Turbomeca	TM 333 2M2	Cheetan (1)/Cheetal (1)	824	735	N/A	N/A	N/A
Turbomeca	TM 333 2B2	DHRUV (2)	824	735	0.315	26.5	166
Turbomeca	Ardiden 1H1	DHRUV (2)	1024	858	0.280	29.8	N/A
Turbomeca	Makila 1A	Eurocopter AS 332	1240	1130	N/A	N/A	N/A

Manufacturer	Type of the engine	Helicopter, in which the engine is built in	Take off power (kW)	Max continuous (kW)	Specific fuel consumption (kg/kWh)	Thermal efficiency (%)	Mass (kg)
Turbomeca	Makila 1A1	Eurocopter AS 332L1/AS 532	1357	884	0.294	28.3	235
Turbomeca	Makila 1A2	Eurocopter AS 332MK2 (2)/ AS532MK2	1376	1236	0.290	28.8	235
Turbomeca	Makila 2A	Eurocopter EC 725/ EC 225 (2)	1564	1411	0.285	29.2	N/A
Turbomeca	Makila 2A1	Eurocopter EC 725/ EC 225 (2)	1567	1418	N/A	N/A	N/A
Turbomeca	Makila 1K2	Denel Roivalk (2)	1376	1236	0.290	28.8	235
Klimov	GTD 350	Mi-2	298	N/A	0.489	17.0	135
Klimov	TV2-117	Mi-8	1119	N/A	0.369	22.6	334
Klimov	TV3-117	Mi-24A	1659	N/A	N/A	N/A	N/A
Klimov	TV3-117M	Mi-14	1659	N/A	N/A	N/A	N/A
Klimov	TV3-117MT	Mi-8MT/Mi-17	1659	N/A	N/A	N/A	N/A
Klimov	TV3-117KM	Ka-27	1659	N/A	N/A	N/A	N/A
Klimov	TV3-117V	Mi-24	1566	N/A	N/A	N/A	N/A
Klimov	TV3-117VK	Ka-27. Ka-29. Ka-32	1641	N/A	N/A	N/A	N/A
Klimov	TV3-117VM	Mi-8MT/Mi-17	1491	N/A	N/A	N/A	N/A
Klimov	TV3-117VMA	Ka-27. Ka-29. Ka-31. Mi-24. Mi-28A/N. Ka-32	1641	N/A	0.288	28.9	295
Klimov	VK-2500 I	8MT/Mi-17. Mi-24. Mi-14. Ka-32. Ka-50. Mi-28	1491	N/A	0.295	28.2	300
Klimov	VK-2500 II	8MT/Mi-17. Mi-24. Mi-14. Ka-32. Ka-50. Mi-28	1641	N/A	0.287	29.0	300
Klimov	VK-2500 II	8MT/Mi-17. Mi-24. Mi-14. Ka-32. Ka-50. Mi-28	1790	N/A	0.282	29.6	300
Klimov	TV7-117V/VM	Mi-38	2088	N/A	0.295	28.2	360
Klimov	TV7-117VK	Mi-28. Ka-50. Ka-52	2088	N/A	0.308	27.0	380
Klimov	VK-800V	Ansats. Mi-54. Ka-126. Ka-226	597	447	0.390	21.3	140

Manufacturer	Type of the engine	Helicopter, in which the engine is built in	Take off power (kW)	Max continuous (kW)	Specific fuel consumption (kg/kWh)	Thermal efficiency (%)	Mass (kg)
Ivchenko-Progress	D-136	Mi-26. Mi-26T	8501	N/A	0.266	31.4	1077

